

Strain Gauge Measurement – A Tutorial

What is Strain?

Strain is the amount of deformation of a body due to an applied force. More specifically, strain (ϵ) is defined as the fractional change in length, as shown in Figure 1 below.

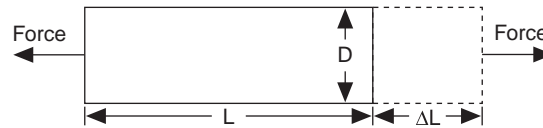

$$\epsilon = \frac{\Delta L}{L}$$

Figure 1. Definition of Strain

Strain can be positive (tensile) or negative (compressive). Although dimensionless, strain is sometimes expressed in units such as in./in. or mm/mm. In practice, the magnitude of measured strain is very small. Therefore, strain is often expressed as microstrain ($\mu\epsilon$), which is $\epsilon \times 10^{-6}$.

When a bar is strained with a uniaxial force, as in Figure 1, a phenomenon known as Poisson Strain causes the girth of the bar, D , to contract in the transverse, or perpendicular, direction. The magnitude of this transverse contraction is a material property indicated by its Poisson's Ratio. The Poisson's Ratio ν of a material is defined as the negative ratio of the strain in the transverse direction (perpendicular to the force) to the strain in the axial direction (parallel to the force), or $\nu = -\epsilon_T/\epsilon$. Poisson's Ratio for steel, for example, ranges from 0.25 to 0.3.

The Strain Gauge

While there are several methods of measuring strain, the most common is with a strain gauge, a device whose electrical resistance varies in proportion to the amount of strain in the device. For example, the piezoresistive strain gauge is a semiconductor device whose resistance varies nonlinearly with strain. The most widely used gauge, however, is the bonded metallic strain gauge.

The metallic strain gauge consists of a very fine wire or, more commonly, metallic foil arranged in a grid pattern. The grid pattern maximizes the amount of metallic wire or foil subject to strain in the parallel direction (Figure 2). The cross sectional area of the grid is minimized to reduce the effect of shear strain and Poisson Strain. The grid is bonded to a thin backing, called the carrier, which is attached directly to the test specimen. Therefore, the strain experienced by the test specimen is transferred directly to the strain gauge, which responds with a linear change in electrical resistance. Strain gauges are available commercially with nominal resistance values from 30 to 3000 Ω , with 120, 350, and 1000 Ω being the most common values.

Product and company names are trademarks or trade names of their respective companies.

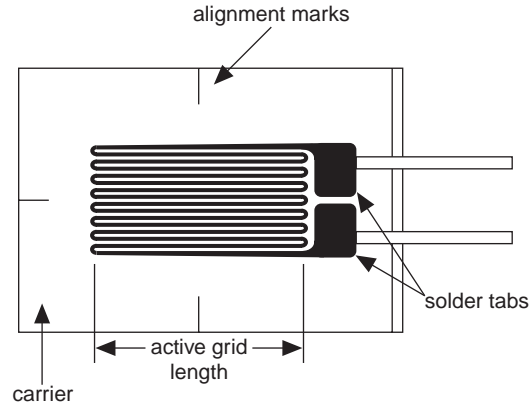

Figure 2. Bonded Metallic Strain Gauge

It is very important that the strain gauge be properly mounted onto the test specimen so that the strain is accurately transferred from the test specimen, through the adhesive and strain gauge backing, to the foil itself. Manufacturers of strain gauges are the best source of information on proper mounting of strain gauges.

A fundamental parameter of the strain gauge is its sensitivity to strain, expressed quantitatively as the gauge factor (GF). Gauge factor is defined as the ratio of fractional change in electrical resistance to the fractional change in length (strain):

$$GF = \frac{\Delta R/R}{\Delta L/L} = \frac{\Delta R/R}{\epsilon}$$

The Gauge Factor for metallic strain gauges is typically around 2.

Ideally, we would like the resistance of the strain gauge to change only in response to applied strain. However, strain gauge material, as well as the specimen material to which the gauge is applied, will also respond to changes in temperature. Strain gauge manufacturers attempt to minimize sensitivity to temperature by processing the gauge material to compensate for the thermal expansion of the specimen material for which the gauge is intended. While compensated gauges reduce the thermal sensitivity, they do not totally remove it. For example, consider a gauge compensated for aluminum that has a temperature coefficient of 23 ppm/°C. With a nominal resistance of 1000 Ω, GF = 2, the equivalent strain error is still 11.5 με/°C. Therefore, additional temperature compensation is important.

Strain Gauge Measurement

In practice, the strain measurements rarely involve quantities larger than a few millistrain ($\epsilon \times 10^{-3}$). Therefore, to measure the strain requires accurate measurement of very small changes in resistance. For example, suppose a test specimen undergoes a substantial strain of 500 με. A strain gauge with a gauge factor GF = 2 will exhibit a change in electrical resistance of only $2 \cdot (500 \times 10^{-6}) = 0.1\%$. For a 120 Ω gauge, this is a change of only 0.12 Ω.

To measure such small changes in resistance, and compensate for the temperature sensitivity discussed in the previous section, strain gauges are almost always used in a bridge configuration with a voltage or current excitation source. The general Wheatstone bridge, illustrated below, consists of four resistive arms with an excitation voltage, V_{EX} , that is applied across the bridge.

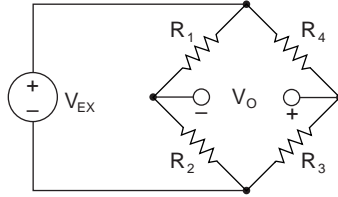

Figure 3. Wheatstone Bridge

The output voltage of the bridge, V_O , will be equal to:

$$V_O = \left[\frac{R_3}{R_3 + R_4} - \frac{R_2}{R_1 + R_2} \right] \cdot V_{EX}$$

From this equation, it is apparent that when $R_1/R_2 = R_3/R_4$, the voltage output V_O will be zero. Under these conditions, the bridge is said to be *balanced*. Any change in resistance in any arm of the bridge will result in a nonzero output voltage.

Therefore, if we replace R_4 in Figure 3 with an active strain gauge, any changes in the strain gauge resistance will unbalance the bridge and produce a nonzero output voltage. If the nominal resistance of the strain gauge is designated as R_G , then the strain-induced change in resistance, ΔR , can be expressed as $\Delta R = R_G \cdot GF \cdot \epsilon$. Assuming that $R_1 = R_2$ and $R_3 = R_G$, the bridge equation above can be rewritten to express V_O/V_{EX} as a function of strain (see Figure 4). Note the presence of the $1/(1+GF \cdot \epsilon/2)$ term that indicates the nonlinearity of the quarter-bridge output with respect to strain.

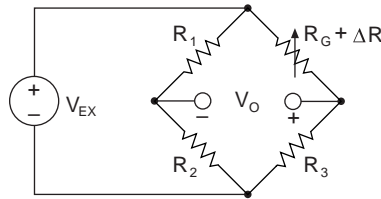

$$\frac{V_O}{V_{EX}} = -\frac{GF \cdot \epsilon}{4} \left(\frac{1}{1 + GF \cdot \frac{\epsilon}{2}} \right)$$

Figure 4. Quarter-Bridge Circuit

By using *two* strain gauges in the bridge, the effect of temperature can be avoided. For example, Figure 5 illustrates a strain gauge configuration where one gauge is active ($R_G + \Delta R$), and a second gauge is placed transverse to the applied strain. Therefore, the strain has little effect on the second gauge, called the dummy gauge. However, any changes in temperature will affect both gauges in the same way. Because the temperature changes are identical in the two gauges, the ratio of their resistance does not change, the voltage V_O does not change, and the effects of the temperature change are minimized.

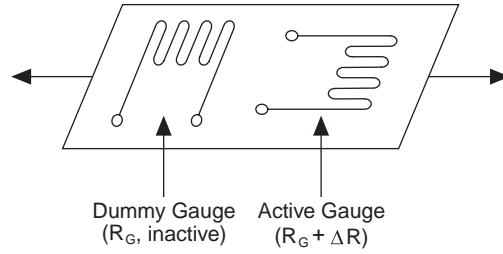
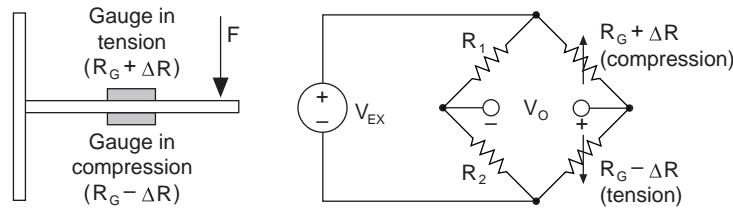

Figure 5. Use of Dummy Gauge to Eliminate Temperature Effects

Alternatively, you can double the sensitivity of the bridge to strain by making both gauges active, although in different directions. For example, Figure 6 illustrates a bending beam application with one bridge mounted in tension ($R_G + \Delta R$) and the other mounted in compression ($R_G - \Delta R$). This half-bridge configuration, whose circuit diagram is also illustrated in Figure 6, yields an output voltage that is linear and approximately doubles the output of the quarter-bridge circuit.



$$\frac{V_O}{V_{EX}} = -\frac{GF \cdot \epsilon}{2}$$

Figure 6. Half-Bridge Circuit

Finally, you can further increase the sensitivity of the circuit by making all four of the arms of the bridge active strain gauges, and mounting two gauges in tension and two gauges in compression. The full-bridge circuit is shown in Figure 7 below.

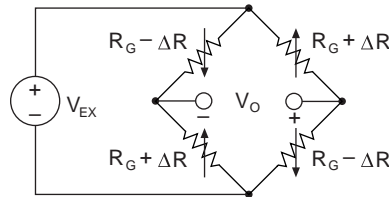

$$\frac{V_O}{V_{EX}} = -GF \cdot \epsilon$$

Figure 7. Full-Bridge Circuit

The equations given here for the Wheatstone bridge circuits assume an initially balanced bridge that generates zero output when no strain is applied. In practice however, resistance tolerances and strain induced by gauge application will generate some initial offset voltage. This initial offset voltage is typically handled in two ways. First, you can use a special offset-nulling, or balancing, circuit to adjust the resistance in the bridge to rebalance the bridge to zero output. Alternatively, you can measure the initial unstrained output of the circuit and compensate in software. At the end of this application note, you will find equations for quarter, half, and full bridge circuits that express strain that take initial output voltages into account. These equations also include the effect of resistance in the lead wires connected to the gauges.

Lead Wire Resistance

The figures and equations in the previous section ignore the resistance in the lead wires of the strain gauge. While ignoring the lead resistances may be beneficial to understanding the basics of strain gauge measurements, doing so in practice can be very dangerous. For example, consider the two-wire connection of a strain gauge shown in Figure 8a. Suppose each lead wire connected to the strain gauge is 15 m long with lead resistance R_L equal to $1\ \Omega$. Therefore, the lead resistance adds $2\ \Omega$ of resistance to that arm of the bridge. Besides adding an offset error, the lead resistance also desensitizes the output of the bridge. From the strain equations at the end of this application note, you can see that the amount of desensitization is quantified by the term $(1 + R_L/R_G)$. You can compensate for this error by measuring the lead resistance R_L and using the measured value in the strain equations. However, a more difficult problem arises from changes in the lead resistance due to temperature changes. Given typical temperature coefficients for copper wire, a slight change in temperature can generate a measurement error of several $\mu\epsilon$.

Therefore, the preferred connection scheme for quarter-bridge strain gauges is the three-wire connection, shown in Figure 8b. In this configuration, R_{L1} and R_{L3} appear in adjacent arms of the bridge. Therefore, any changes in resistance due to temperature cancel each other. The lead resistance in the third lead, R_{L2} , is connected to the measurement input. Therefore, this lead carries very little current and the effect of its lead resistance is negligible.

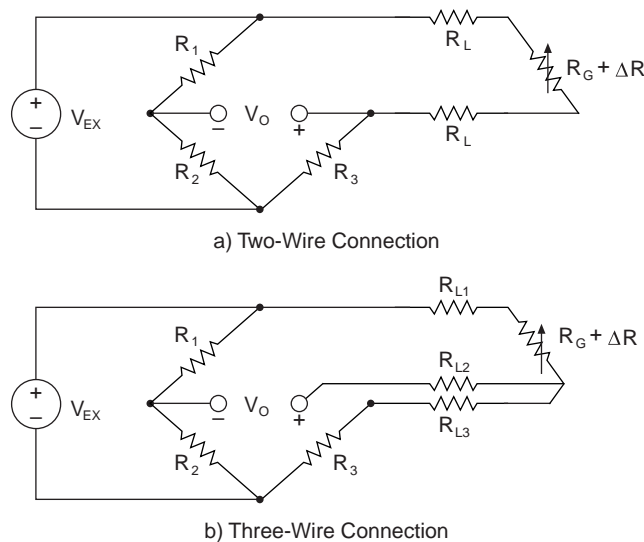

Figure 8. Two-Wire and Three-Wire Connections of Quarter-Bridge Circuit

Signal Conditioning for Strain Gauges

Strain gauge measurement involves sensing extremely small changes in resistance. Therefore, proper selection and use of the bridge, signal conditioning, wiring, and data acquisition components are required for reliable measurements.

Bridge Completion – Unless you are using a full-bridge strain gauge sensor with four active gauges, you will need to complete the bridge with reference resistors. Therefore, strain gauge signal conditioners typically provide half-bridge completion networks consisting of two high-precision reference resistors. Figure 9 diagrams the wiring of a half-bridge strain gauge circuit to a conditioner with completion resistors R_1 and R_2 . The nominal resistance of the completion resistors is less important than how well the two resistors are matched. Ideally, the resistors are well matched and provide a stable reference voltage of $V_{EX}/2$ to the negative input lead of the measurement channel. For example, the half-bridge completion resistors provided on the SCXI-1122 signal conditioning module are $2.5\ k\Omega$ resistors a ratio tolerance of 0.02% . The high resistance of the completion resistors helps minimize the current draw from the excitation voltage.

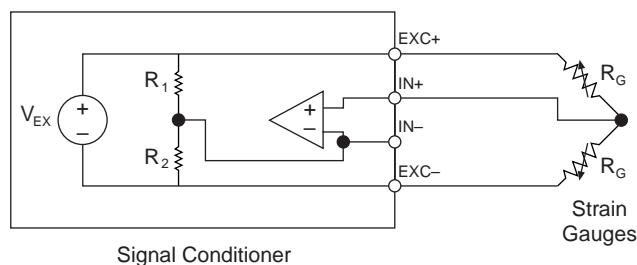

Figure 9. Connection of Half-Bridge Strain Gauge Circuit

Bridge Excitation – Strain gauge signal conditioners typically provide a constant voltage source to power the bridge. While there is no standard voltage level that is recognized industry wide, excitation voltage levels of around 3 V and 10 V are common. While a higher excitation voltage generates a proportionately higher output voltage, the higher voltage can also cause larger errors due to self-heating. Again, it is very important that the excitation voltage be very accurate and stable. Alternatively, one can use a less accurate or stable voltage, and accurately measure, or sense, the excitation voltage so the correct strain can be calculated.

Excitation Sensing – If the strain gauge circuit is located a distance away from the signal conditioner and excitation source, a possible source of error is voltage drops caused by resistance in the wires connecting the excitation voltage to the bridge. Therefore, some signal conditioners include a feature called *remote sensing* to compensate for this error. There are two common methods of remote sensing. With feedback remote sensing, you connect extra sense wires to the point where the excitation voltage wires connect to the bridge circuit. The extra sense wires serve to regulate the excitation supply to compensate for lead losses and deliver the needed voltage *at* the bridge. This scheme is used with the SCXI-1122.

An alternative remote sensing scheme uses a separate measurement channel to measure directly the excitation voltage delivered across the bridge. Because the measurement channel leads carry very little current, the lead resistance has negligible effect on the measurement. The measured excitation voltage is then used in the voltage-to-strain conversion to compensate for lead losses.

Signal Amplification – The output of strain gauges and bridges is relatively small. In practice, most strain gauge bridges and strain-based transducers will output less than 10 mV/V (10 mV of output per volt of excitation voltage). With a 10 V excitation voltage, the output signal will be 100 mV. Therefore, strain gauge signal conditioners usually include amplifiers to boost the signal level to increase measurement resolution and improve signal-to-noise ratios. SCXI signal conditioning modules, for example, include configurable gain amplifiers with gains up to 2000.

Bridge Balancing, Offset Nulling – When a bridge is installed, it is very unlikely that the bridge will output exactly zero volts when no strain is applied. Rather, slight variations in resistance among the bridge arms and lead resistance will generate some nonzero initial offset voltage. There are a few different ways that a system can handle this initial offset voltage.

1. *Software Compensation* – The first method compensates for the initial voltage in software. With this method, you take an initial measurement before strain input is applied. This initial voltage is then used in the strain equations listed at the end of this application note. This method is simple, fast, and requires no manual adjustments. The disadvantage of the software compensation method is that the offset of the bridge is not removed. If the offset is large enough, it limits the amplifier gain you can apply to the output voltage, thus limiting the dynamic range of the measurement.
2. *Offset-Nulling Circuit* – The second balancing method uses an adjustable resistance, or potentiometer, to physically adjust the output of the bridge to zero. For example, Figure 10 illustrates the offset nulling circuit of the SCXI-1321 terminal block. By varying the position of the potentiometer (R_{POT}), you can control the level of the bridge output and set the initial output to zero volts. The value of R_{NULL} sets the range that the circuit can balance. On the SCXI-1321, this resistor is socketed for easy adjustment of the balancing range.

3. **Buffered Offset Nulling** – The third method, like the software method, does not affect the bridge directly. With buffered nulling, a nulling circuit adds an adjustable DC voltage to the output of the instrumentation amplifier. For example, the SC-2043-SG strain gauge accessory uses this method. The SC-2043-SG includes a user-adjustable potentiometer that can add ± 50 mV to the output of an instrumentation amplifier that has a fixed gain of 10. Therefore, the nulling range, referred to input, is ± 5 mV.

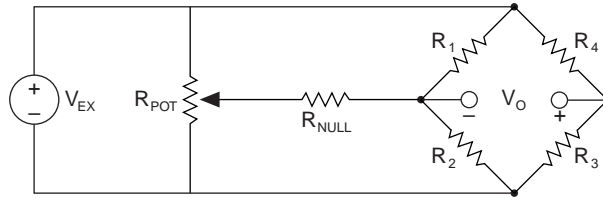

Figure 10. Offset-Nulling Circuit of SCXI-1321 Terminal Block

Shunt Calibration – The normal procedure to verify the output of a strain gauge measurement system relative to some predetermined mechanical input or strain is called shunt calibration. Shunt calibration involves simulating the input of strain by changing the resistance of an arm in the bridge by some known amount. This is accomplished by shunting, or connecting, a large resistor of known value across one arm of the bridge, creating a known ΔR . The output of the bridge can then be measured and compared to the expected voltage value. The results can then be used to correct span errors in the entire measurement path, or to simply verify general operation to gain confidence in the setup.

SCXI and Strain Gauge Measurement

Signal Conditioning eXtensions for Instrumentation (SCXI) is a signal conditioning and data acquisition system for PC-based instrumentation applications. An SCXI system consists of a shielded chassis that houses a combination of signal conditioning input and output modules, which perform a variety of signal conditioning functions. You can connect many different types of transducers, including strain gauges, directly to SCXI modules. The SCXI system can operate as a front-end signal conditioning system for PC plug-in or PCMCIA data acquisition boards. Alternatively, you can use an SCXI data acquisition module that digitizes the analog signals and connects directly to the parallel port of the PC.

Two SCXI modules, the SCXI-1121 and SCXI-1122, are designed for use with strain gauge transducers. Table 1 summarizes some of the module features that relate to strain gauge measurements.

SCXI-1121 – The SCXI-1121 is a 4-channel isolation amplifier module with transducer excitation. The SCXI-1121 includes an independent gain amplifier and lowpass noise filter on each channel with complete channel-to-channel electrical isolation. Each channel also includes a completely isolated excitation source and a half-bridge completion circuit. The SCXI-1321 terminal block, used with the SCXI-1121 module, adds manual offset-nulling and programmable shunt calibration for each channel.

SCXI-1122 – The SCXI-1122 is a 16-channel signal conditioning module. The SCXI-1122 combines a 16-channel input multiplexer with a single programmable gain isolation amplifier for economical, isolated measurements. The SCXI-1122 also includes a half-bridge completion circuit, shunt calibration, and a single voltage excitation source of 3.333 V.

Table 1. SCXI-1121 and SCXI-1122 Features for Strain Gauges

	SCXI-1121	SCXI-1122
Number of channels	4	16
Electrical isolation	channel-to-channel	input-to-output
Multiplexer scan rate¹	to 333 kS/s	100 S/s
Amplifier gain	1 to 2000	0.01 to 2000
Excitation voltage source	3.333 V or 10.0 V (one per channel)	3.333 V (one per module)
Excitation current drive	28 mA at 3.333 V 14 mA at 10.0 V (per channel)	225 mA (per module)
Half-bridge completion	Yes	Yes
Offset nulling	Yes ²	No
Shunt calibration	Yes ²	Yes
Remote excitation sensing	No	Yes

¹ Multiplexer (mux) scan rate depends on DAQ board or module. Specified rate of 333 kS/s is attainable with AT-MIO-16E-2 or AT-MIO-16E-1.

² With SCXI-1321 terminal block.

Note that Table 1 lists the current drive of the excitation voltage sources. The current drawn by the strain gauge bridge circuit will depend on the gauge resistance, bridge configuration (quarter, half, or full), and the voltage level. Table 2 summarizes the current requirements of common strain gauge bridge configurations. For example, a half-bridge circuit with 120 Ω strain gauges will draw 14 mA from a 3.333 V source, or 43 mA from a 10.0 V source. Therefore, you must configure the SCXI-1121 for 3.333 V excitation, because each channel can provide 28 mA at 3.333 V, but only 14 mA at 10.0 V. The SCXI-1122 can provide 225 mA at 3.333 V, which is enough to drive sixteen 120 Ω half-bridge circuits.

Table 2. Current Requirements for Typical Strain Gauge Circuits

Bridge Configuration	Excitation Voltage	
	3.333 V	10 V
120 Ω full-bridge	28 mA	83 mA ¹
120 Ω quarter or half-bridge ²	14 mA	43 mA ¹
350 Ω full-bridge	10 mA	29 mA ¹
350 Ω quarter or half-bridge ²	5 mA	15 mA
1000 Ω full-bridge	3.3 mA	10 mA
1000 Ω quarter or half-bridge ²	2 mA	6 mA

¹ These configurations exceed the current drive capabilities of the SCXI-1121

² Assuming half-bridge completion resistors of $R = 4.5 \text{ k}\Omega$

SCXI Strain Gauge Application

We will use a real-world application to illustrate the use of SCXI to acquire strain gauge measurements. An experimental aircraft model is instrumented with 16 half-bridge, 350 Ω strain gauge transducers ($GF = 2$). The model will be placed in a wind tunnel where its performance under simulated wind forces will be measured. From past tests, we can expect strain values to reach no higher than 600 $\mu\epsilon$. A PC will monitor and record the 16 strain parameters.

From the half-bridge equation in Figure 6, the magnitude of the half-bridge output at full strain input will be $(GF \cdot \epsilon) / 2 = 0.3 \text{ mV/V}$. Therefore, the full-scale bridge output will be 1 mV if the excitation voltage is 3.333 V or 3 mV if the excitation voltage is 10 V.

If per-channel filtering and/or high-speed acquisition are required, then four SCXI-1121 modules should be used. Each channel of the SCXI-1121 would be configured for half-bridge completion, a voltage excitation of 10 V, and a gain of 1000. At this gain, the input range of each channel will be $\pm 5 \text{ mV}$, which can accommodate the $\pm 3 \text{ mV}$ output of the bridge. The 16 strain gauge bridges are wired to screw terminals of four SCXI-1321 terminal blocks. This configuration is illustrated in Figure 11.

Alternatively, you could use one SCXI-1122 module to acquire all 16 strain gauge inputs. The maximum scan rate of the SCXI-1122 module is 100 S/s, which for this application will yield a per channel sampling rate of about 6 S/s. If this rate is sufficient, and the per channel filtering and isolation are not required, then the SCXI-1122 may be used. The voltage excitation of the SCXI-1122 is 3.333 V, meaning the strain gauge bridges will output 1 mV. At a gain of 2000, the SCXI-1122 input range is $\pm 5 \text{ mV}$.

Whether the SCXI-1121 or SCXI-1122 is used, the conditioned input signals are multiplexed back to a single plug-in DAQ board or PCMCIA DAQCard. Alternatively, an SCXI digitizer module, such as the SCXI-1200, can digitize the signals locally, communicating to the PC digitally via the PC parallel port or serial communications.

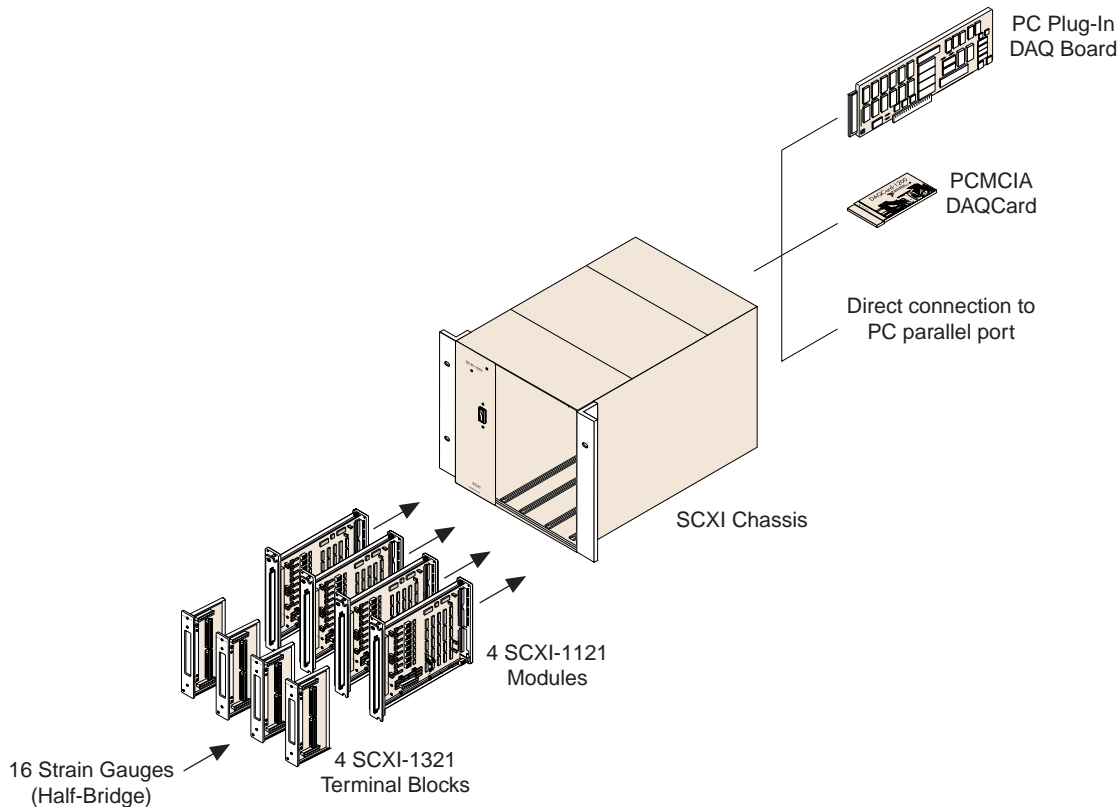

Figure 11. Example SCXI System Configuration for Strain Gauges

SC-2043-SG – Low-Cost Signal Conditioner

For applications that don't require the flexibility, expandability, or rugged packaging of an SCXI system, the SC-2043-SG provides eight channels of low-cost strain gauge signal conditioning. The SC-2043-SG is a circuit board with screw terminals for direct sensor wire connections. A cable connects the output signals from the SC-2043-SG directly to a plug-in DAQ board, PCMCIA DAQCard, or DAQPad-1200 parallel port device, as illustrated in Figure 12. Features of the SC-2043-SG are listed in Table 3.

Table 3. SC-2043-SG Features for Strain Gauges

	SC-2043-SG
Number of channels	8
Amplifier gain	10 (in addition to DAQ board gain)
Excitation voltage source	2.5 V, or user can supply voltage
Excitation current drive	167 mA
Excitation sensing	Yes, local sensing
Half-bridge completion	Yes (with sockets for quarter-bridge completion resistors)
Offset nulling	Yes
Shunt calibration	No

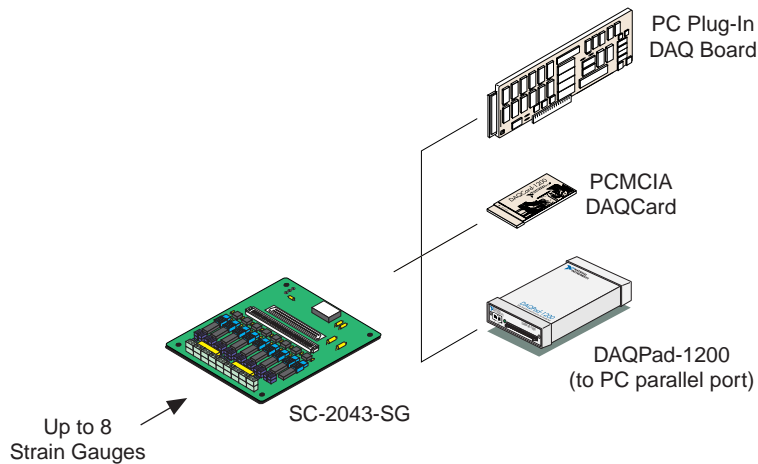

Figure 12. Strain Gauge Measurement with SC-2043-SG Signal Conditioner

Strain Gauge Equations

This section includes the complete strain gauge equations for several types of bridge configurations. These equations are included as callable functions (with source code) with the NI-DAQ driver software. The function names are `Strain_Convert` and `Strain_Buf_Convert`. With LabVIEW, these equations are included in the *Convert Strain Gauge Reading.vi* in the DAQ Utilities menu.

To simplify the equations and account for unbalanced bridges in the nonstrained state, let us introduce the ratio V_r :

$$V_r = \frac{V_{O(\text{strained})} - V_{O(\text{unstrained})}}{V_{EX}}$$

where $V_{O(\text{strained})}$ is the measured output when strained, and $V_{O(\text{unstrained})}$ is the initial, unstrained output voltage. V_{EX} is the excitation voltage.

Also, the designation $(+\epsilon)$ and $(-\epsilon)$ indicates active strain gauges mounted in tension and compression, respectively. The designation $(-\nu\epsilon)$ indicates that the strain gauge is mounted in the transversal direction, so that its resistance change is primarily due to the Poisson's Strain, whose magnitude is given as $-\nu\epsilon$.

Other nomenclature used in the equations include:

R_G = nominal resistance value of strain gauge

GF = gauge factor of strain gauge

R_L = lead resistance

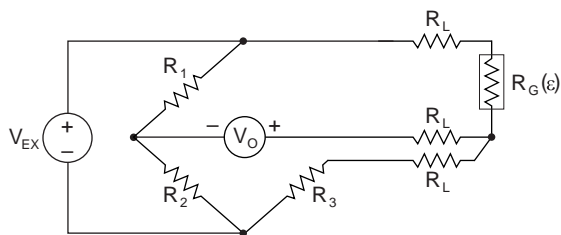

Quarter-Bridge I

$$\text{strain}(\epsilon) = \frac{-4V_r}{GF(1 + 2V_r)} \cdot \left(1 + \frac{R_L}{R_G}\right)$$

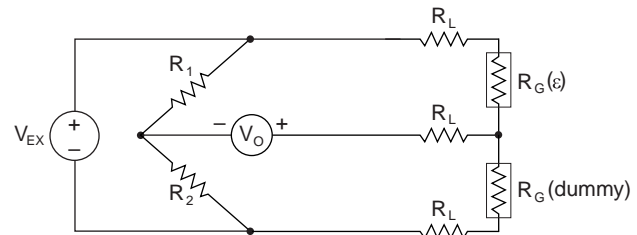

Quarter-Bridge II

$$\text{strain}(\epsilon) = \frac{-4V_r}{GF(1 + 2V_r)} \cdot \left(1 + \frac{R_L}{R_G}\right)$$

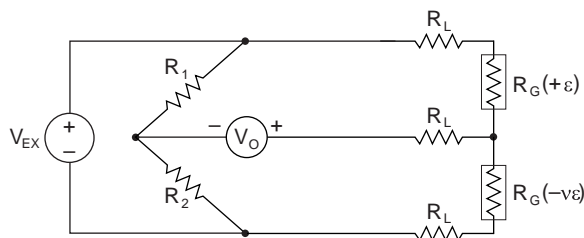

Half-Bridge I

$$\text{strain}(\epsilon) = \frac{-4V_r}{GF[(1 + \nu) - 2V_r(\nu - 1)]} \cdot \left(1 + \frac{R_L}{R_G}\right)$$

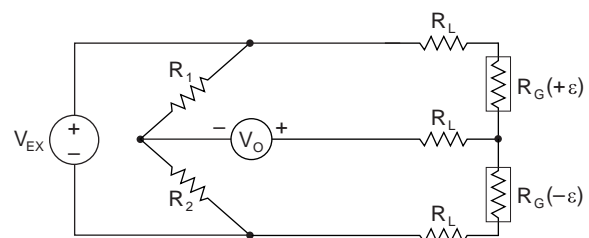

Half-Bridge II

$$\text{strain}(\epsilon) = \frac{-2V_r}{GF} \cdot \left(1 + \frac{R_L}{R_G}\right)$$

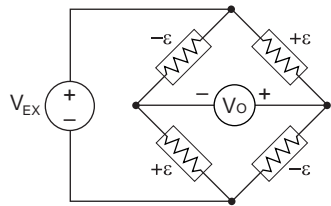

Full-Bridge I

$$\text{strain}(\epsilon) = \frac{-V_r}{GF}$$

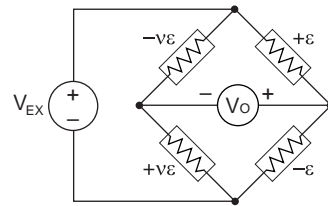

Full-Bridge II

$$\text{strain}(\epsilon) = \frac{-2V_r}{GF(v+1)}$$

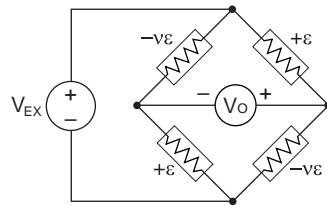

Full-Bridge III

$$\text{strain}(\epsilon) = \frac{-2V_r}{GF[(v+1) - V_r(v-1)]}$$

